

D1-13A, D1-13B, D1-20A, D1-20B, D1-30A, D1-30B, D2-40A, D2-40B, D1-13F, D1-20F, D1-30F, D2-40F

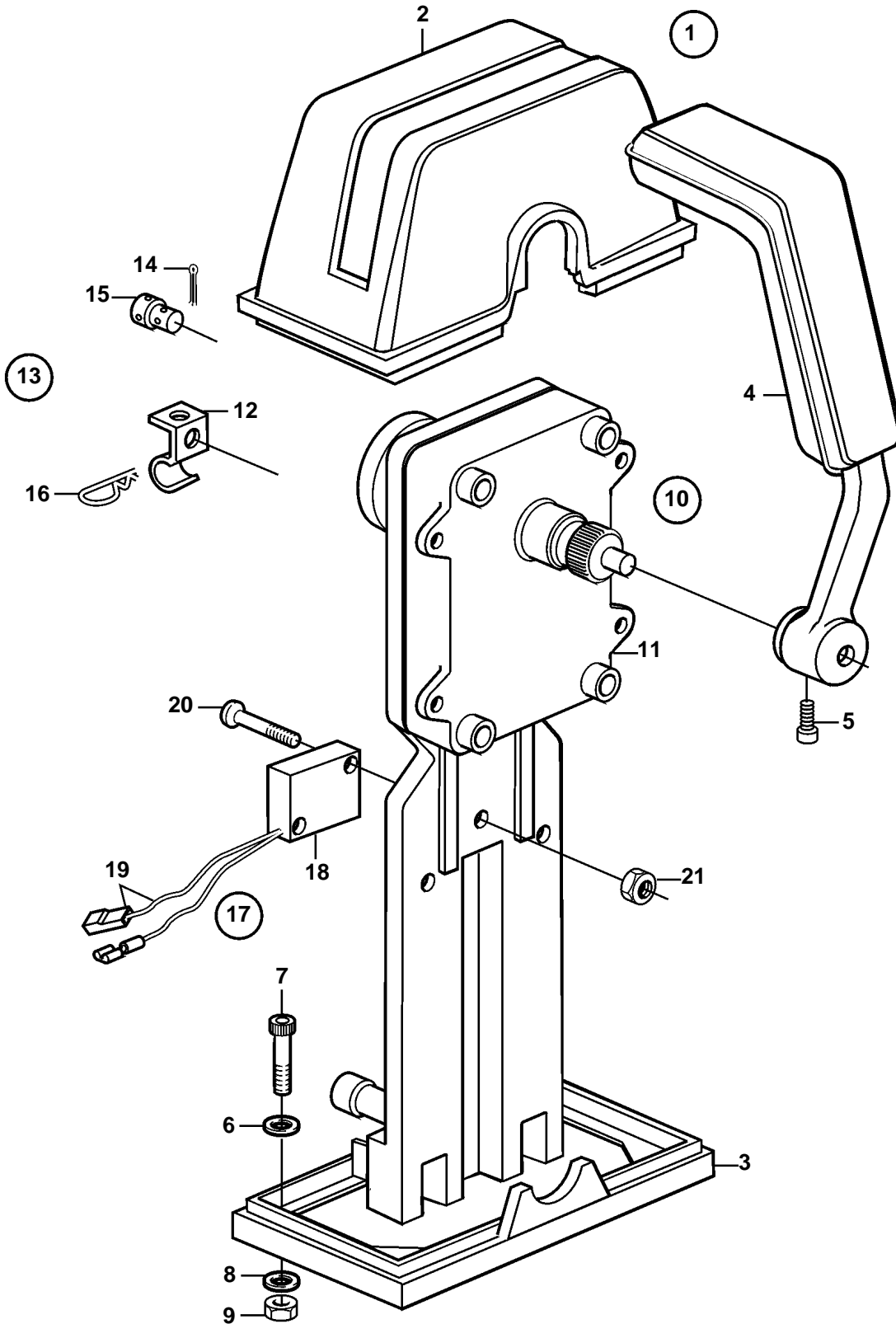

D1-13A, D1-13B, D1-20A, D1-20B, D1-30A, D1-30B, D2-40A, D2-40B, D1-13F, D1-20F, D1-30F, D2-40F

REF	PART NO.	QTY	DESCRIPTION	SEE SEC.	NOTES
1	851603	1	Mounting kit		
2	850824	1	· Cover		(839477)
3	839479	1	· Plate		
4	839475	2	· Hand lever		
5	839693	2	· Lock screw		
6	940090	2	· Washer		
7	947671	6	· Hex. socket screw		
8	960138	6	· Washer		
9	955780	6	· Hexagon nut		
10	851600	2	Control		
11		2	· Control mechanism		
12	853423	2	· Retainer		
13		2	· Connector kit		
14	17253	4	· · Split pin		
15	839638	4	· · Cube		
16	852924	2	· · Clip		
17	855352	2	Neutral position con		
18	850200	2	· Toggle switch		
19		X	· · Cables and terminals	1963	
20	946177	4	· Cross recessed screw		
21	947536	4	· Hexagon nut		